

PRODUCT SPECIFICATIONS

IRON VALLEY LUNCH TABLE - 48"

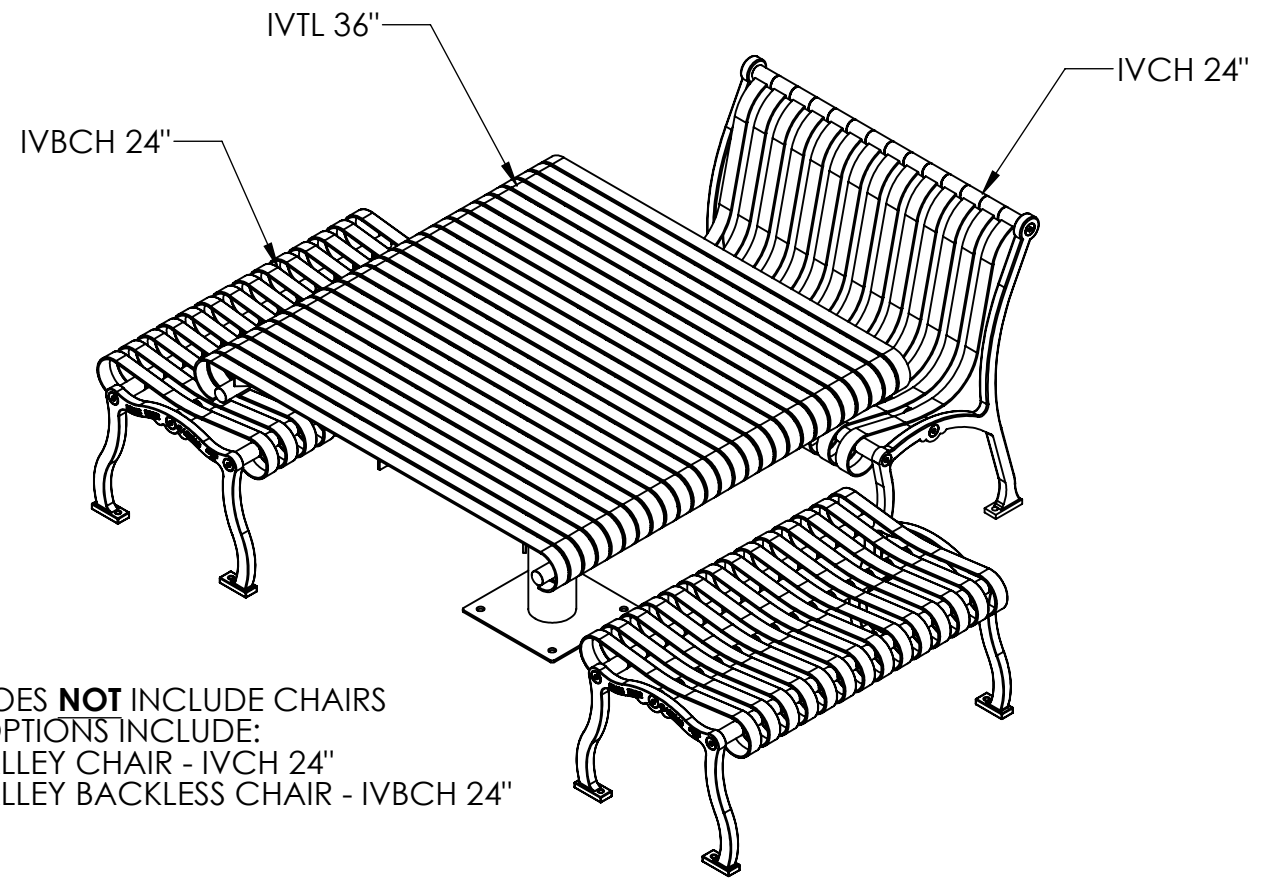

NOTE:
TABLE DOES **NOT** INCLUDE CHAIRS
CHAIR OPTIONS INCLUDE:
IRON VALLEY CHAIR - IVCH 24"
IRON VALLEY BACKLESS CHAIR - IVBCH 24"

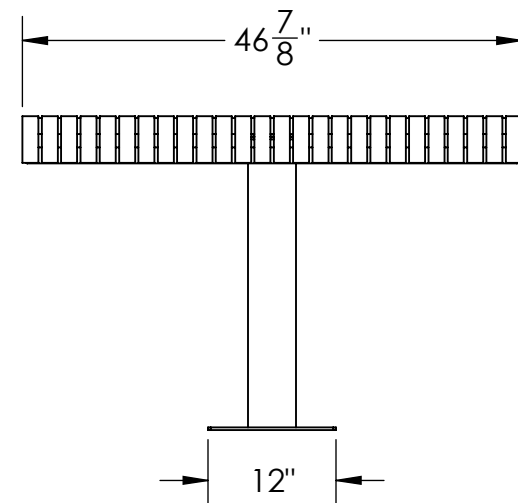
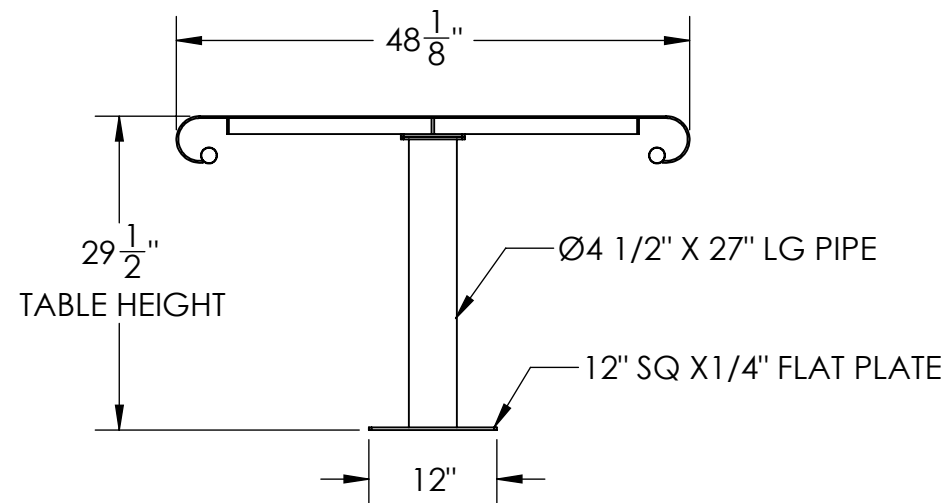
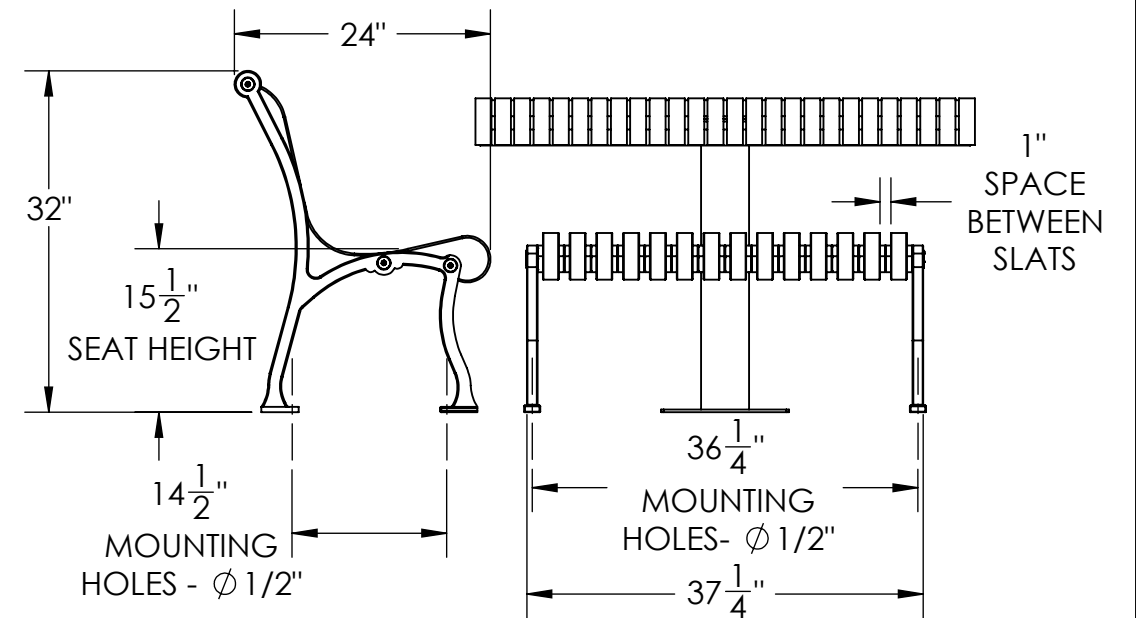
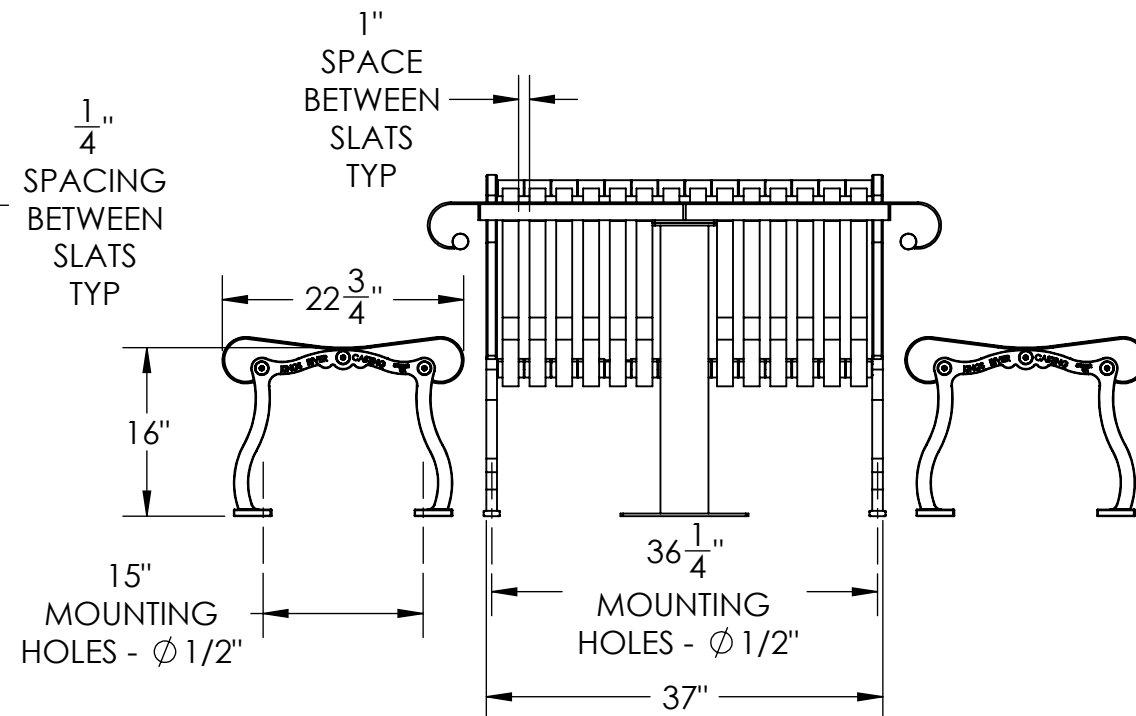
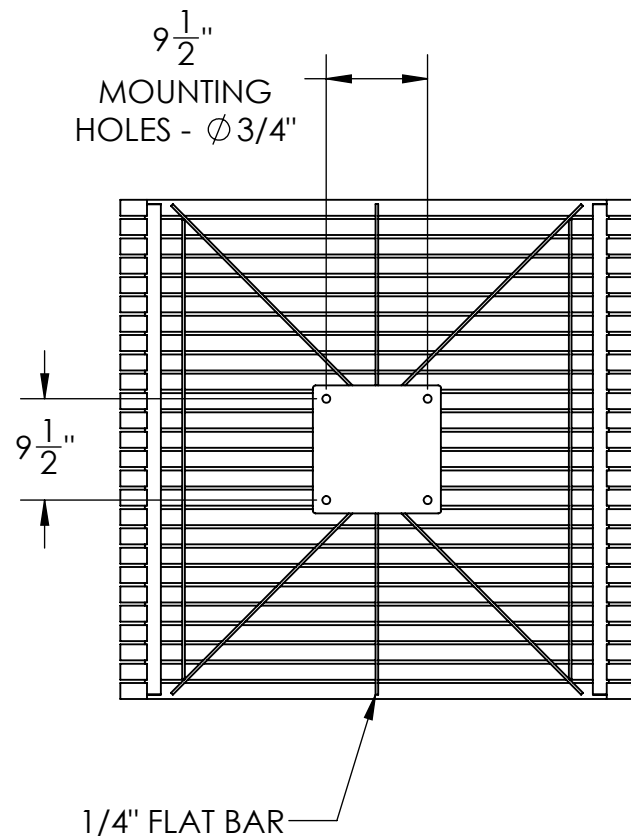

NOTE:
ALL SLATS ARE FORMED
ASTM 1018 COLD ROLLED
STEEL - 1 1/2" X 3/16"

DESCRIPTION:

IRON VALLEY LUNCH TABLE - 48"

ADDRESS:
1350 NORTH AVE.
SANGER, CALIFORNIA 93857
PHONE: (559) 875-8250
FAX: (559) 875-1491
kingsrivercasting@verizon.net

THE INFORMATION CONTAINED IN THIS DRAWING
IS THE SOLE PROPERTY OF KINGS RIVER CASTING.
ANY REPRODUCTION IN PART OR WHOLE WITHOUT THE
WRITTEN PERMISSION OF KINGS RIVER CASTING IS PROHIBITED.

WEIGHT: 215 LBS
MODEL NUMBER:

SCALE: 1:18

IVLT - 48"

SIZE
B